



Technical Guidance  
Document E: 2014  
Insulation requirements

**ROCKWOOL®**

# SUMMARY GUIDE

This document provides a quick and easy reference guide of typical constructions using ROCKWOOL insulation products that will assist the end user in meeting the performance levels required by the Part E of the Building Regulations in Ireland.

The new regulations apply to works or changes of use that occur on or after 1st July 2015, at which point the 1997 regulations become obsolete.

## Introduction

### Application of Part E

The diagram below summarises the areas of a building to which Part E applies, ensuring that dwellings achieve reasonable levels of sound insulation from adjoining buildings or differently occupied parts of the same building.

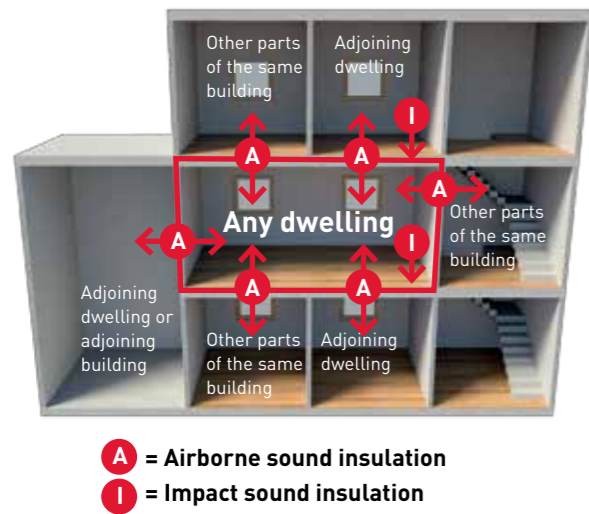

### Performance

The  $D_{nT,w}$  and  $L_{nT,w}$  figures in the table below include flanking transmission. As such, when looking at laboratory-tested  $R_w$  figures, these should aim to improve on the targets by at least 5 dB to help ensure compliance.

Sound performance levels		
Separating construction	Airborne sound insulation $D_{nT,w}$ dB	Impact sound insulation $L_{nT,w}$ dB
Walls	53 (min)	-
Floors (including stairs with a separating function)	53 (min)	58 (max)

### Compliance

The Department of Environment, Community and Local Government has given several construction types which, if constructed correctly, should achieve the performance levels given in the table above.

This guide outlines ROCKWOOL products and solutions that will comply with this guidance.

Please note that this is merely a summary focussing on insulation requirements. Full guidance can be found in TGD-E.

## Separating Walls

### 1. Wall Type 1 (WT 1) - Solid masonry / concrete with plaster finish

The sound resistance of this wall type depends mainly on the mass of the wall.

#### WT 1A - Solid masonry plastered on both faces

##### Specification

The minimum area weight of the wall should be 415 kg/m<sup>2</sup>. Minimum 13mm plaster to each face.

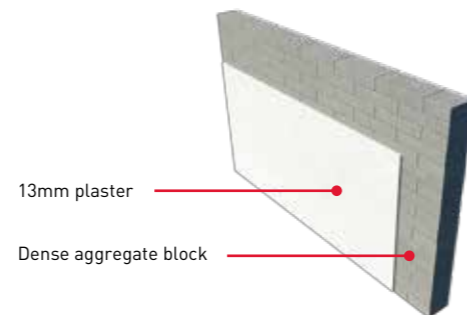

##### Example construction

- 215mm dense aggregate concrete block (min. 1900 kg/m<sup>3</sup>) laid flat
- 13mm plaster (10 kg/m<sup>2</sup>) each side

#### WT 1B - Dense concrete plastered on both faces

##### Specification

The minimum area weight of the wall should be 415 kg/m<sup>2</sup>. Minimum 13mm plaster to each face.

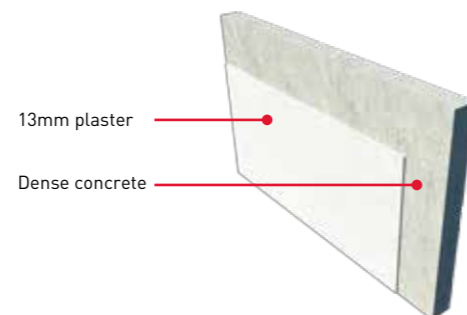

##### Example construction

- 190mm dense concrete cast or in-situ (min. 2200 kg/m<sup>3</sup>)
- 13mm plaster (10 kg/m<sup>2</sup>) each side

### WT 1 - Flanking insulation requirements

The cavity should be stopped with ROCKWOOL Party Wall Cavity Barrier (PWCB) to minimise sound transmission along the cavity, unless the cavity is fully filled with ROCKWOOL Cavity.

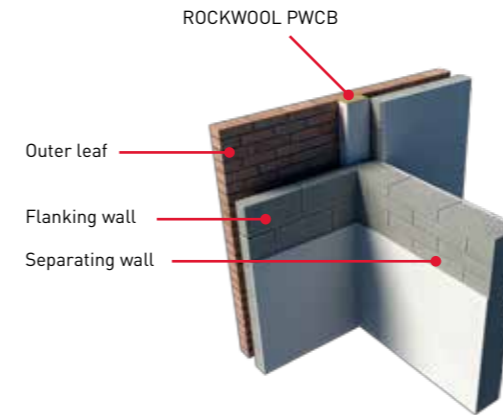

ROCKWOOL PWCB also meets the requirements of the cavity stop specified in Part B - Fire Safety. For more information, please see Technical Guidance Document B.

### WT 1 - Junctions with ceiling and roof

The wall should be continuous to the underside of the roof (but may be unplastered) and the junction between the separating wall and the roof should be filled with ROCKWOOL FLEXI® which is also suitable as a fire stop.

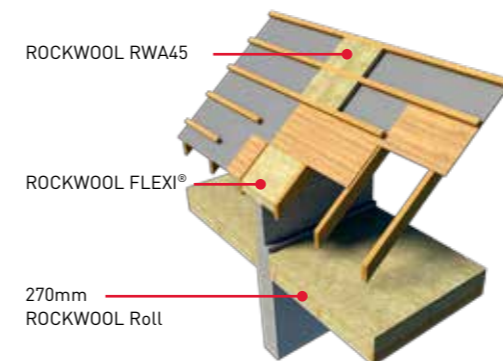

The cavities of external walls should be closed at eaves level using ROCKWOOL TCB.

### 2. Wall Type 2 (WT 2) - Solid masonry with dry lining

The sound resistance of this wall type depends on the mass of the blockwork, the absorptive performance of the ROCKWOOL, and the isolation of the dry-lining.

##### Specification

The minimum area weight of the wall, including linings, should be 415 kg/m<sup>2</sup>.

##### Wall lining

The block wall faces should be lined with 100mm ROCKWOOL Roll.

The walls should be lined with a gypsum-based board with an area weight of 10 kg/m<sup>2</sup>, fixed to either:

- Timber battens at max. 400mm centres
- Metal frame spaced at max. 400mm centres and secured to the wall by brackets

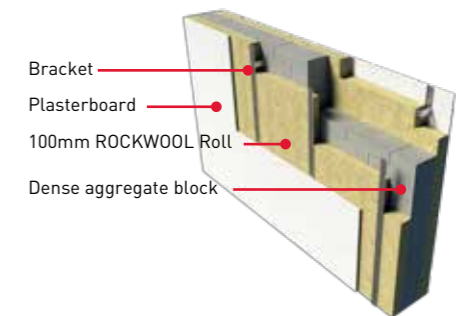

##### Example construction

- 215mm solid dense block (1900 kg/m<sup>3</sup>)
- 100mm ROCKWOOL Roll both sides
- Timber battens at 400mm centres, fixed through the quilt such that the ROCKWOOL Roll is compressed
- 12.5mm plasterboard min. 10 kg/m<sup>2</sup> both sides

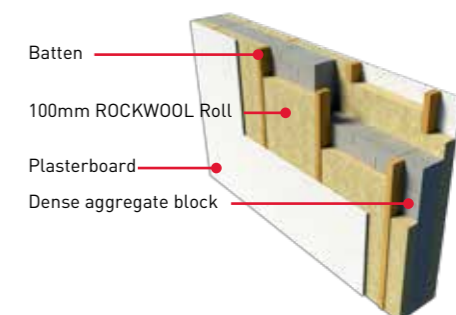

### WT 2 - Flanking insulation requirements

The cavity should be stopped with ROCKWOOL PWCB to minimise sound transmission along the cavity, unless the cavity is fully filled with ROCKWOOL Cavity.

### WT 2 - Junction with ceiling and roof

The wall should be continuous to the underside of the roof, and the junction between the separating wall and the roof should be filled with ROCKWOOL FLEXI®, which is also suitable as a fire stop.

The cavities of external walls should be closed at eaves level using ROCKWOOL Thermal Cavity Barrier (TCB).

### 3. Wall Type 3 (WT 3) - Cavity masonry with plaster finish

The sound resistance of this wall type depends on the area weight of the blockwork, and the level of isolation between the inner and outer leaves. Workmanship is key since any mortar snots that bridge the cavity or sit on wall ties will weaken performance.

#### Specification

The minimum area weight of the wall, including linings, should be 415 kg/m<sup>2</sup>. Minimum 13mm plaster to each face.

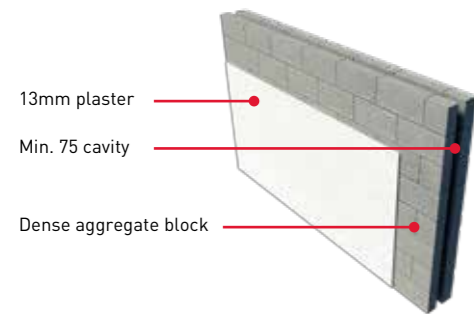

#### Example construction

- 2 x 100mm dense aggregate block (min. 1900 kg/m<sup>3</sup>)
- 75mm cavity (min.)
- 13mm plaster (10 kg/m<sup>2</sup>) each side

### WT 3 - Flanking insulation requirements

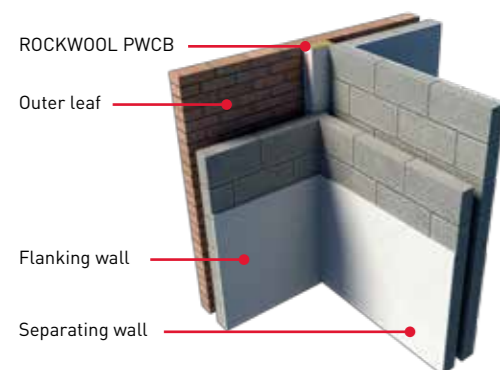

The external cavity wall junction should be stopped with ROCKWOOL PWCB to minimise sound transmission along the cavity, unless the cavity is fully filled with ROCKWOOL Cavity.

### WT 3 - Junction with ceiling and roof

The wall should be continuous to the underside of the roof, and the junction between the separating wall and the roof should be filled with ROCKWOOL FLEXI®.

The cavities of external walls should be closed at eaves level using ROCKWOOL TCB.

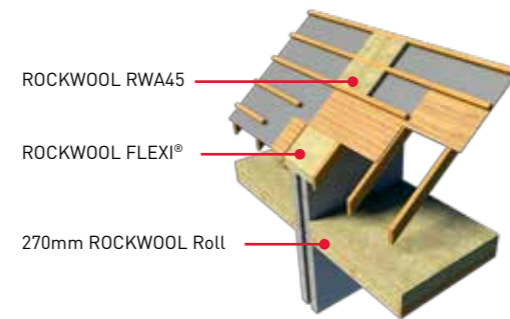

### 4. Wall Type 4 (WT 4) - Timber framed wall with absorbent material

The sound resistance of this wall type depends on the mass of the plasterboard linings, the absorptive performance of ROCKWOOL, and the isolation of the frames.

### WT 4A - Twin leaf timber frame without sheathing

#### Specification

- Min. 240mm between inner faces of wall linings
- Min. 50mm gap between studs

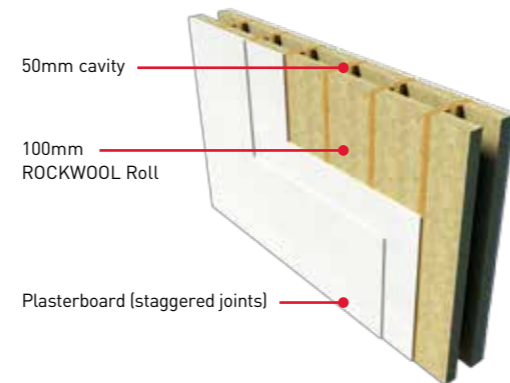

### Wall lining

Two layers of gypsum board, staggered joints, total area weight each side of 22 kg/m<sup>2</sup>.

### Absorbent material

100mm ROCKWOOL Roll in each stud.

### WT 4B - Twin leaf timber frame with sheathing

#### Specification

- Min. 240mm between inner faces of wall linings
- Min. 50mm gap between inner faces of sheathing

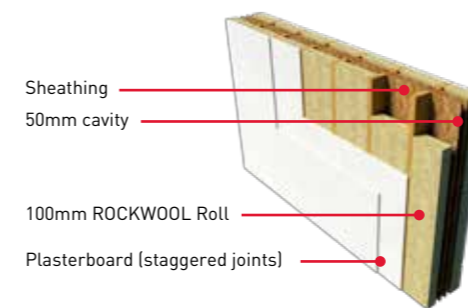

### Wall lining

Two layers of gypsum board, staggered joints, total area weight each side of 22 kg/m<sup>2</sup>.

### Absorbent material

100mm ROCKWOOL Roll in each stud.

### WT 4 - Flanking Requirements

The external cavity should be stopped with ROCKWOOL PWCB to minimise sound transmission along the cavity.

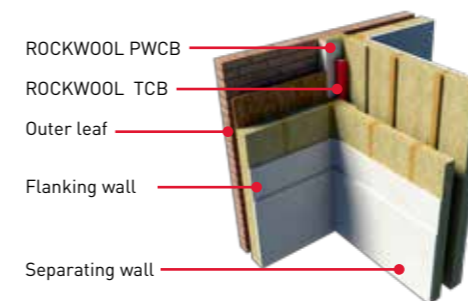

The cavity of the separating wall should be closed with ROCKWOOL TCB.

### WT 4 - Junction with ceiling and roof

The wall should be continuous to the underside of the roof, and the junction between the separating wall and the roof should be filled with ROCKWOOL PWCB, which is also suitable as a fire stop. The cavities of external walls should be closed at eaves level using ROCKWOOL TCB.

### WT 4 - Junction with timber floor

Internal floors should not be continuous between dwellings. The horizontal cavity should be stopped with ROCKWOOL TCB.

## Separating Floors

### 1. Floor Type 1 - FT1 Resilient material on concrete base with ceiling underneath

The airborne sound resistance of this floor type depends on the mass of the concrete slab and ceiling.

The impact sound resistance depends on the level of isolation provided by the resilient layer.

#### A) FT1A—Solid concrete floor

#### Specification

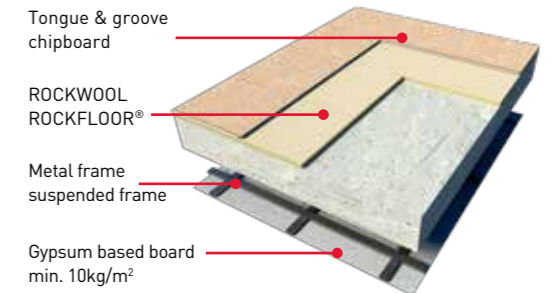

The area weight of the slab should be min. 365 kg/m<sup>2</sup>.

#### Example construction

- 18mm T&G board
- 25mm ROCKWOOL ROCKFLOOR®
- 200mm concrete slab (2400 kg/m<sup>3</sup>)
- Ceiling treatment\*

\*Single layer of 10 kg/m<sup>2</sup> plasterboard fixed to timber battens and / or counter battens or proprietary resilient channels / metal ceiling systems, with an optional layer of ROCKWOOL Roll covering the ceiling board area.

## B) FT1B - Precast concrete hollowcore floor

### Specification

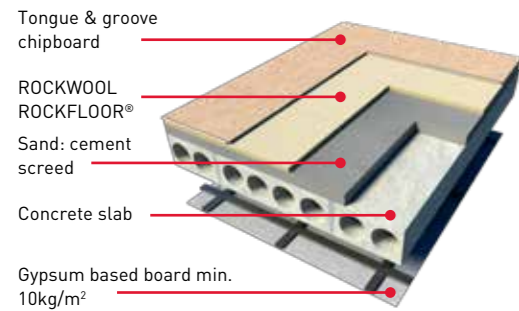

The area weight of the slab should be min. 365 kg/m<sup>2</sup>.

### Example construction

- 18mm T&G board
- 25mm ROCKWOOL ROCKFLOOR®
- 65mm screed
- 200mm (min.) deep precast concrete floor planks ceiling treatment\*

\*Single layer of 10 kg/m<sup>2</sup> plasterboard fixed to timber battens and/or counter battens or proprietary resilient channels/metal ceiling systems, with an optional layer of ROCKWOOL Roll covering the ceiling board area.

### FT 1 - Flanking insulation requirements

The external cavity should be stopped at floor slab level with ROCKWOOL SP Firestop.

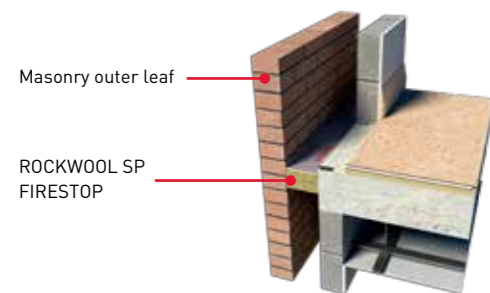

If a high degree of movement is expected, the external cavity should be stopped at floor slab level with ROCKWOOL FIREPRO® SoftSeal.

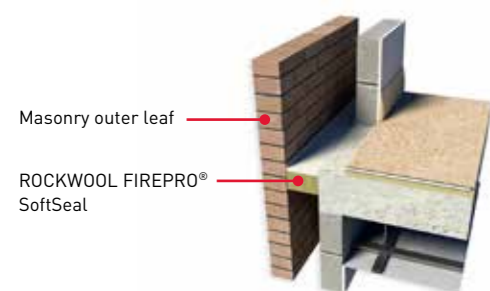

## FT 1 - Services

Fully wrap service pipe over its full height and any branches with ROCKWOOL Roll. The pipe should be boxed in with two layers of standard 12.5mm plasterboard.

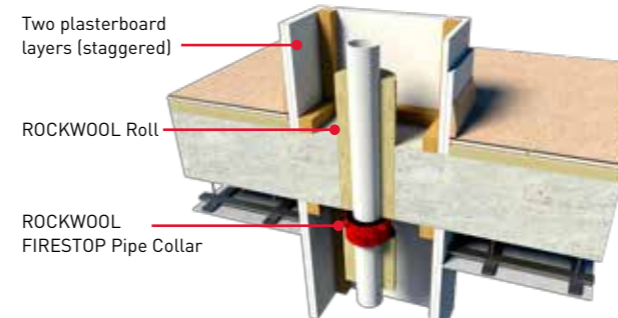

Penetrations through a separating floor by ducts and pipes should be fire protected to satisfy Building Regulations Part B - please contact ROCKWOOL Technical for advice on selecting an appropriate product.

## 2. Floor Type 2 (FT 2) - Floating layer on concrete base with ceiling under

The airborne sound resistance of this floor type depends on the mass of the concrete slab and ceiling.

The impact sound resistance depends on the level of isolation provided by the floating layer.

### A) FT2A-Solid concrete floor

#### Specification

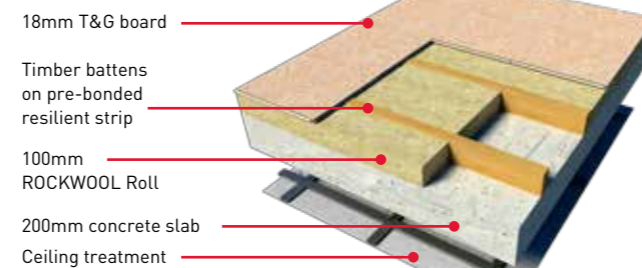

#### Example construction

- 18mm T&G board
- Timber battens pre-bonded to a resilient strip
- ROCKWOOL Roll between battens
- 200mm concrete slab
- Ceiling treatment (as per FT 1)

## B) FT2B - Precast concrete hollowcore floor

### Specification

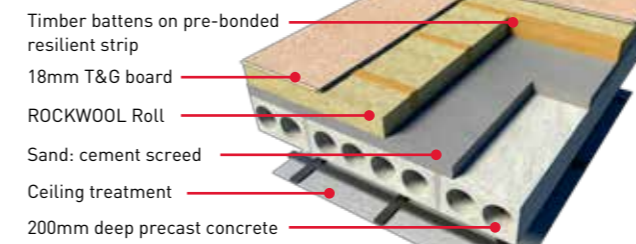

#### Example construction

- 18mm T&G board
- Timber battens pre-bonded to a resilient strip
- ROCKWOOL Roll between battens
- 65mm screed
- 200mm precast concrete floor planks
- Ceiling treatment (as per FT 1)

### FT 2 - Flanking insulation requirements

The external cavity should be stopped at floor slab level with ROCKWOOL SP Firestop.

If a high degree of movement is expected, the external cavity should be stopped at floor slab level with ROCKWOOL FIREPRO® SoftSeal.

### FT 2 - Services

Fully wrap service pipe over its full height and any branches with ROCKWOOL Roll. The pipe should be boxed in with two layers of standard 12.5mm plasterboard.

Penetrations through a separating floor by ducts and pipes should be fire protected to satisfy Building Regulations Part B - please contact ROCKWOOL Technical for advice on selecting an appropriate product.

## 2. Floor Type 3 (FT 3) - Floating layer on timber base with ceiling under

The airborne sound resistance of this floor type depends on the mass of the concrete slab and ceiling.

The impact sound resistance depends on the level of isolation provided by the floating layer.

### Example construction

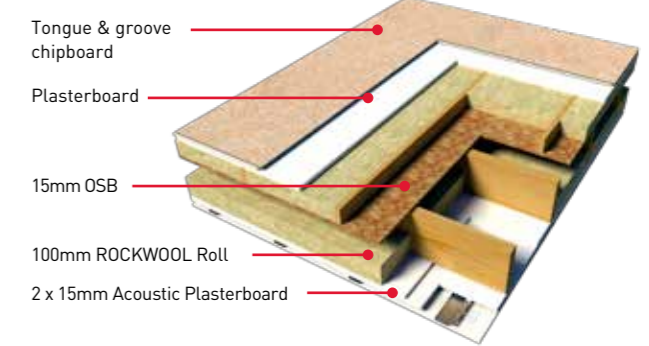

- 18mm T&G board
- 19mm plasterboard
- 70mm timber battens pre-bonded to a resilient strip with ROCKWOOL Roll between
- 15mm OSB
- 220mm deep solid timber joists at 400mm centres (max.)
- 100mm ROCKWOOL Roll between joists
- 2 x 15mm standard plasterboard fixed to underside of joists, joints staggered
- 12.5mm acoustic plasterboard on resilient bars

### FT 3 - Flanking

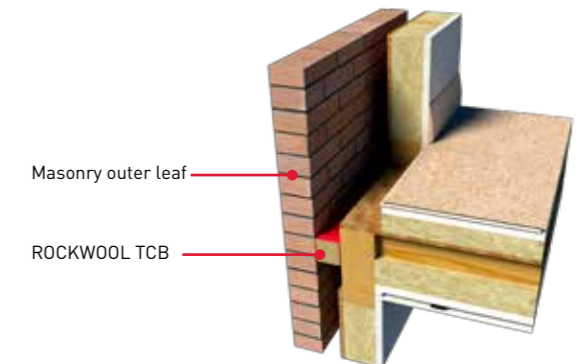

The external cavity should be stopped at floor slab level with ROCKWOOL TCB.

ROCKWOOL Limited  
Pencoed  
Bridgend  
CF35 6NY

01656 862 621  
info@rockwool.co.uk

**ROCKWOOL®**



rockwool.co.uk



@ROCKWOOLUK



ROCKWOOLUK



ROCKWOOL UK